





## available models

models without fixing slide

function	distance (m)	10...30 Vdc DECOUT®		20...60 Vdc / 20...253 Vac	relay
		no timer function	timer function	no timer function	timer function
background suppression	0,05...0,3	RXS/00-1A	RXS/0T-1A	RXS/00-3A	RXS/0T-3A
	0,25...1	RXL/00-1A	RXL/0T-1A	RXL/00-3A	RXL/0T-3A
diffuse reflection	1	RX6/00-1A	RX6/0T-1A	RX6/00-3A	RX6/0T-3A
	2	RX8/00-1A	RX8/0T-1A	RX8/00-3A	RX8/0T-3A
	4,5	RX8/00-1A37	RX8/0T-1A37	RX8/00-3A37	RX8/0T-3A37
retroreflective	12	RXC/00-1A	RXC/0T-1A	RXC/00-3A	RXC/0T-3A
polarized	6	RXP/00-1A	RXP/0T-1A	RXP/00-3A	RXP/0T-3A
emitter	-	-	-	RXE/00-3A	-
emitter with check	-	-	-	-	-
receiver	16...32	-	-	RXR/00-3A	RXR/0T-3A

Maxi with static output DC or with relay output AC/DC

## available models

models with fixing slide

function	distance (m)	10...30 Vdc DECOUT®		20...60 Vdc / 20...253 Vac	relay
		no timer function	timer function	no timer function	timer function
background suppression	0,05...0,3	RXS/00-1B	RXS/0T-1B	RXS/00-3B	RXS/0T-3B
	0,25...1	RXL/00-1B	RXL/0T-1B	RXL/00-3B	RXL/0T-3B
diffuse reflection	1	RX6/00-1B	RX6/0T-1B	RX6/00-3B	RX6/0T-3A
	2	RX8/00-1B	RX8/0T-1B	RX8/00-3B	RX8/0T-3B
	4,5	RX8/00-1B37	RX8/0T-1B37	RX8/00-3B37	RX8/0T-3B37
retroreflective	12	RXC/00-1B	RXC/0T-1B	RXC/00-3B	RXC/0T-3B
polarized	6	RXP/00-1B	RXP/0T-1B	RXP/00-3B	RXP/0T-3B
emitter	-	-	-	RXE/00-3B	-
emitter with check	-	-	-	-	-
receiver	16...32	-	-	RXR/00-3B	RXR/0T-3B

# technical specification

direct diffuse, retro-reflective, background suppression models and through-beam



Maxi with static output DC or with relay output AC/DC

	static output - DC						relay output - AC/DC						
	diffuse reflection		retro-reflective		diffuse reflection		diffuse reflection		retro-reflective		diffuse reflection		through-beam
	-		standard	polarized	background suppr.		-		standard	polarized	background suppr.		without check
	RX6/0*-1*	RX8/0*-1*	RXC/0*-1*	RXP/0*-1*	RXS/0*-1*	RXL/0*-1*	RX6/0*-3*	RX8/0*-3*	RXC/0*-3*	RXP/0*-3*	RXS/0*-3*	RXL/0*-3*	RXE/0*-3* + RXR/0*-3*
nominal sensing distance Sn	1 m <sup>(1)</sup>	2 m <sup>(1)</sup>	12 m <sup>(2)</sup>	6 m <sup>(2)</sup>	0,05... 0,3 m <sup>(1)</sup>	0,25... 1 m <sup>(1)</sup>	1 m <sup>(1)</sup>	2 m <sup>(1)</sup>	12 m <sup>(2)</sup>	6 m <sup>(2)</sup>	0,05... 0,3 m <sup>(1)</sup>	0,25... 1 m <sup>(1)</sup>	16 - 32 m
emission	infrared (880 nm)			red (660 nm)	infrared (880 nm)				red (660 nm)	infrared (880 nm)			
tollerance	- 10...+ 30 %		EG ≥ 2 at Sr		0...+ 10 %		- 10...+ 30 %		EG ≥ 2 at Sr		0...+ 10 %		EG ≥ 2 at Sr
hysteresis	2...10% of the nominal sensing distance Sn												10 %
repeatability	5 %												
operating voltage	10...30 Vdc						20...253 Vac / 50 -60 Hz						
ripple	≤ 10 % max						-						-
no-load supply current	25 mA				40 mA		25 mA <sub>RMS</sub>				30 mA <sub>RMS</sub>		15 mA <sub>RMS</sub> 30 mA <sub>RMS</sub>
load current	≤ 100 mA						-						3A-250 Vac 3A-30 Vdc (750 VA / 90 W)
leakage current	≤ 10 µA						-						
voltage drop	1,2V max						-						
output type	static DECOU <sup>®</sup>						relay						
switching frequency	500 Hz						25 Hz						
power on delay	100 ms												
timing functions	from 0,1s to 10s, deley ON, deley OFF, one shot												
supply electrical protections	polarity reversal, transient						transient (AC), over voltages (DC)						
output protection	AI cortocircuito (memoria)						-						
temperature range	- 25°C...+ 70°C (without freeze)		- 25°C... + 60°C		- 25°C...+ 70°C (without freeze)				- 25°C... + 60°C		- 25°C...+ 70°C		
temperature drift	10 % Sr												
protection degree	IP65 (EN60529) <sup>(3)</sup>												
external light interference	≥ 5.000 lux (incandescent lamp)		≥ 10.000 lux (incandescent lamp)		≥ 5.000 lux (incandescent lamp)				≥ 10.000 lux (incandescent lamp)		≥ 5.000 lux (incandescent lamp)		10.000 lux (incandescent lamp)
emitter LEDs	-												green (supply) red (dist. x 2)
receiver LEDs	rear red (output state), superior red (alignment), green (stable signal)												
housing material	polycarbonate (glass fiber reinforced)												
lenses material	plastic												
weight (approximate)	145 g without fixing slide / 165 g with fixing slide												

<sup>(1)</sup> With 100 x 100 mm white matt paper EG=1.5 <sup>(2)</sup> With standard reflector Ø 80 mm (RL110 supplied seperately) <sup>(3)</sup> Protection guaranteed only with plug cable well mounted



# electrical diagrams of the connections

Maxi with static output DC or with relay output AC/DC

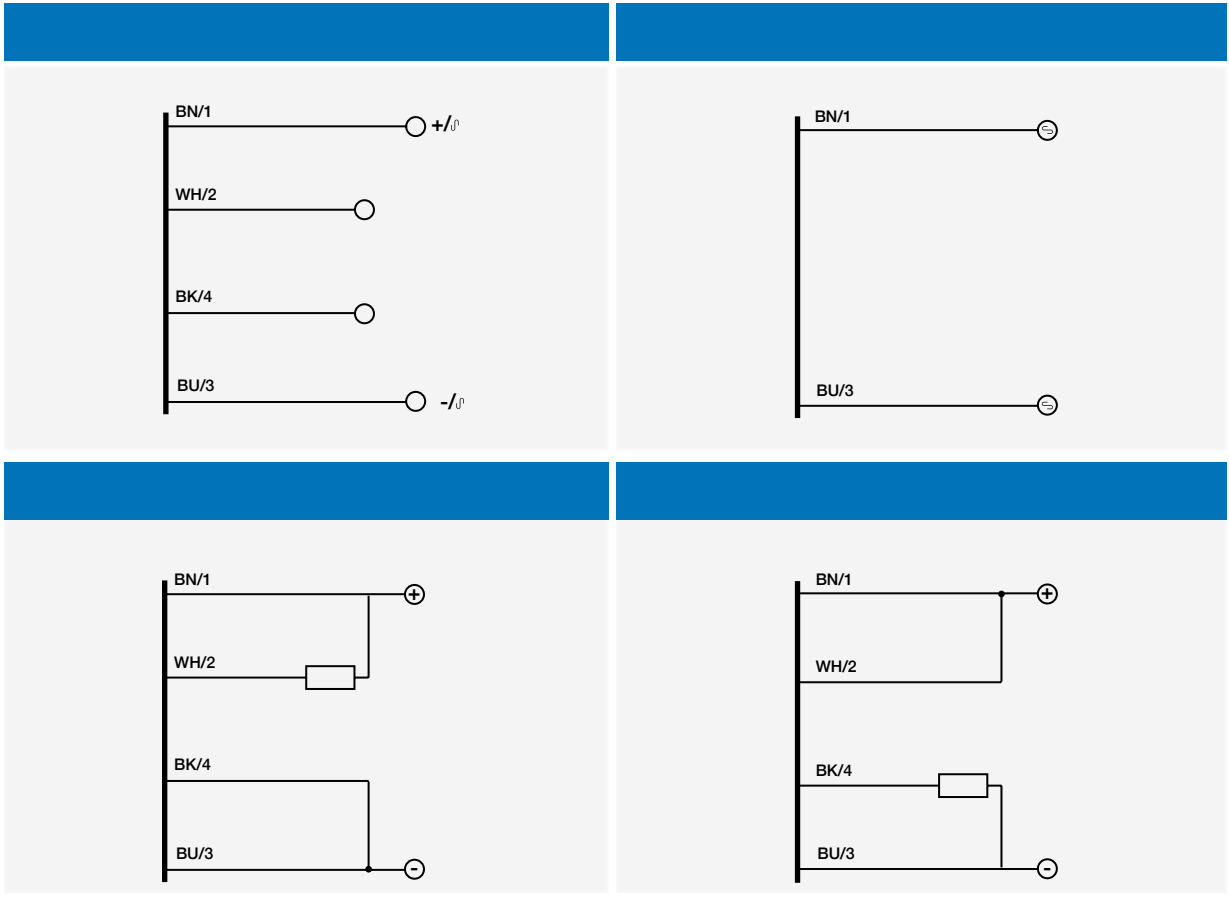

## plug

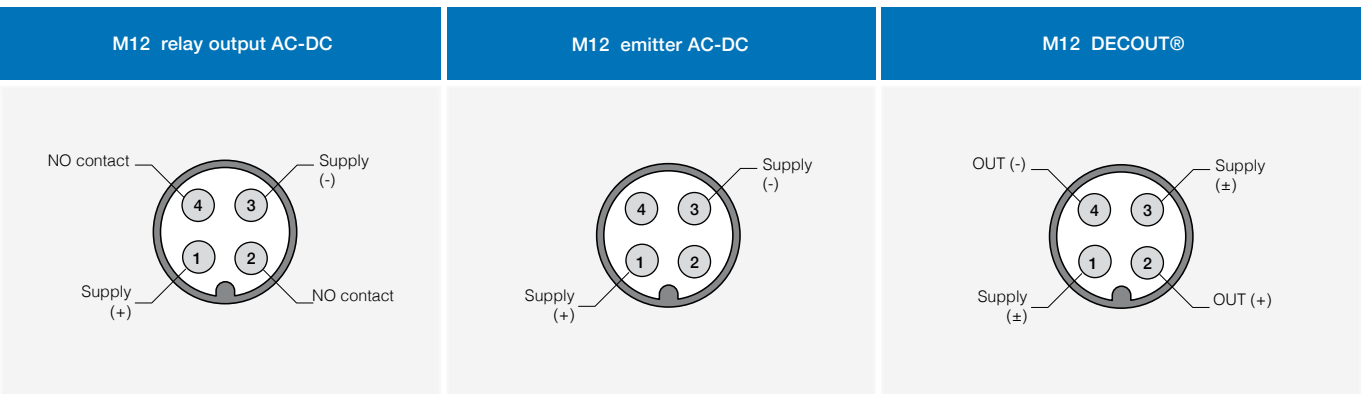

## response diagrams

direct diffuse models

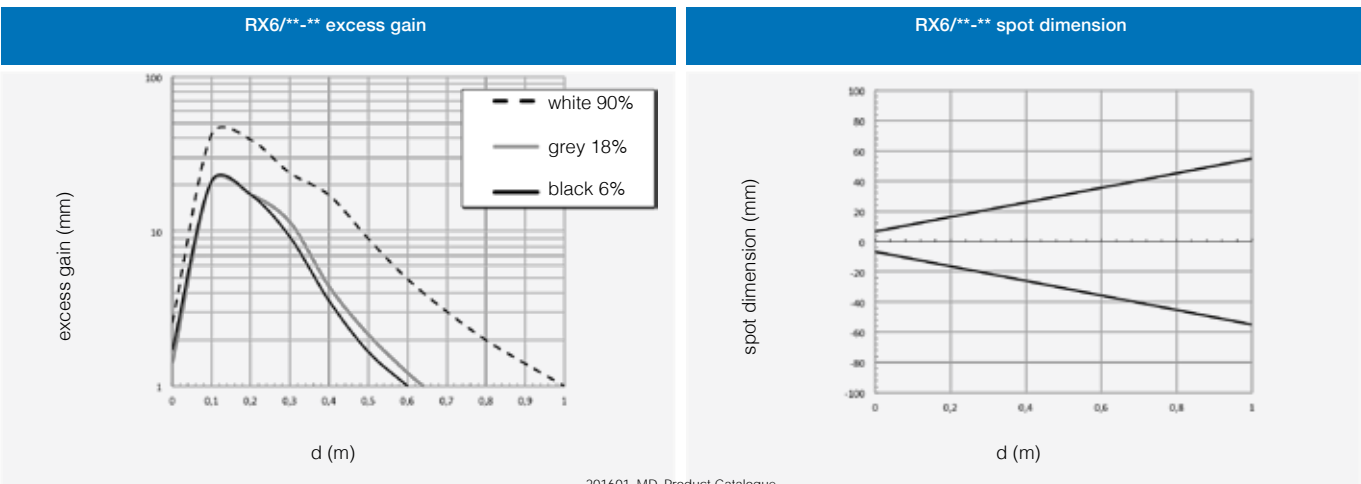

RX



RX6/\*\*-\*\* parallel displacement

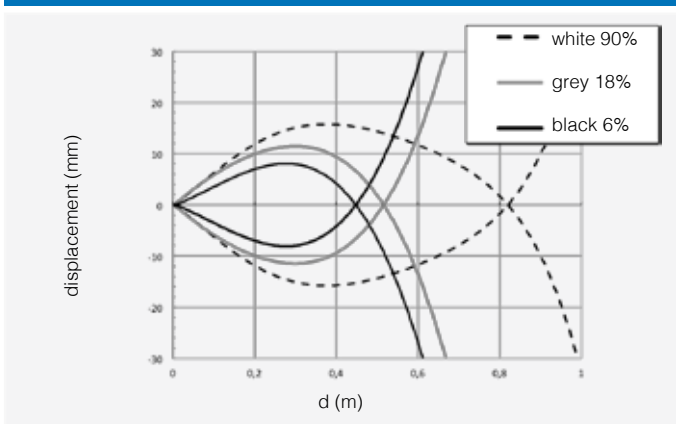

RX8/\*\*-\*\* excess gain

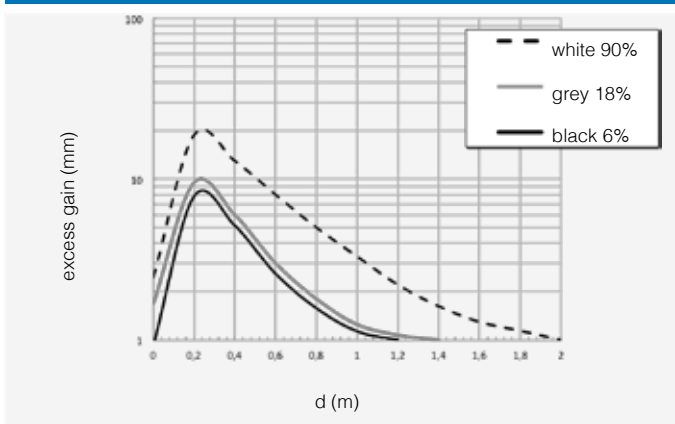

RX8/\*\*-\*\* spot dimension

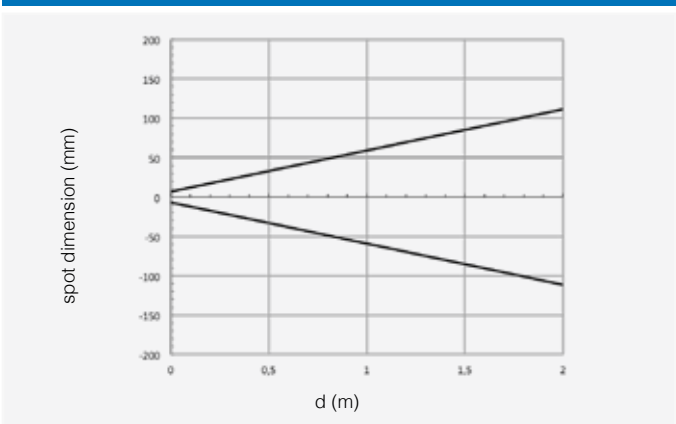

RX8/\*\*-\*\* parallel displacement

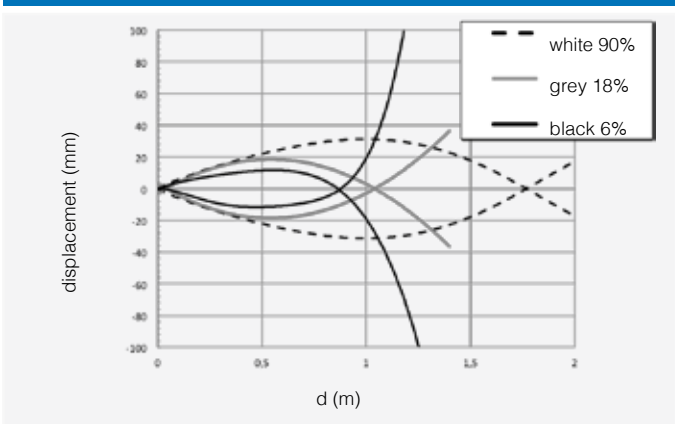

RX8/\*\*-\*\*37 excess gain

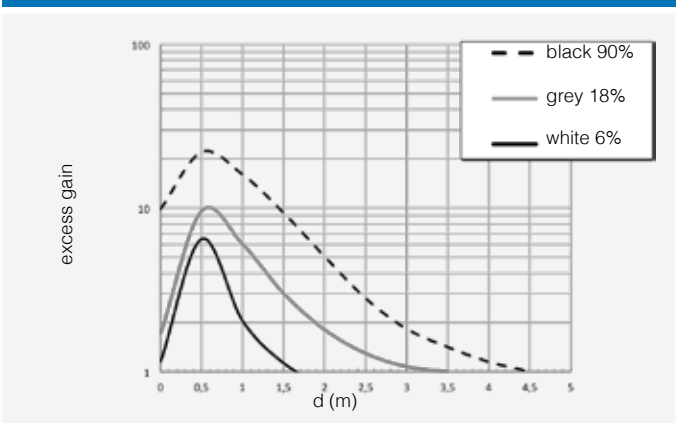

RX8/\*\*-\*\*37 spot diameter

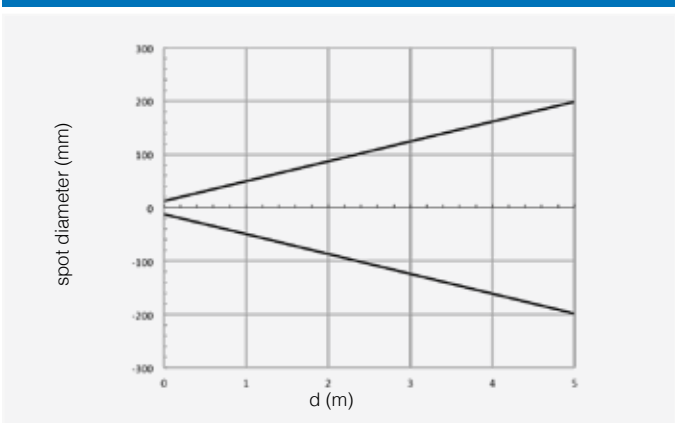

RX8/\*\*-\*\*37 parallel displacement

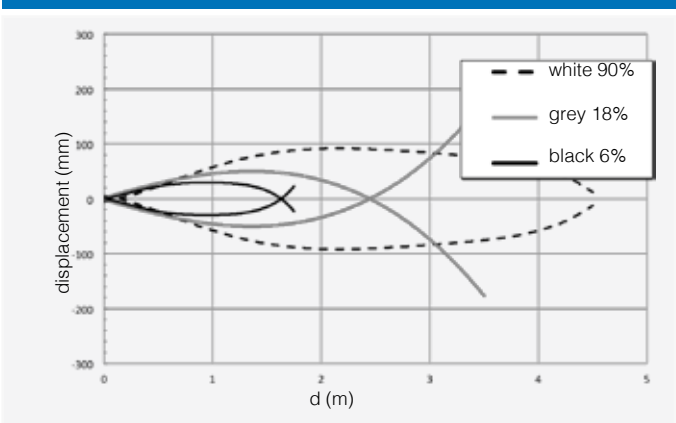



# response diagrams

retro-reflective models

Maxi with static output DC  
or with relay output AC/DC

RXC/\*\*-\*\*excess gain

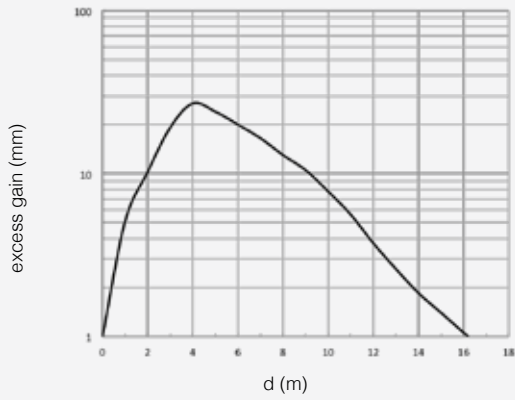

RXC/\*\*-\*\* spot dimension

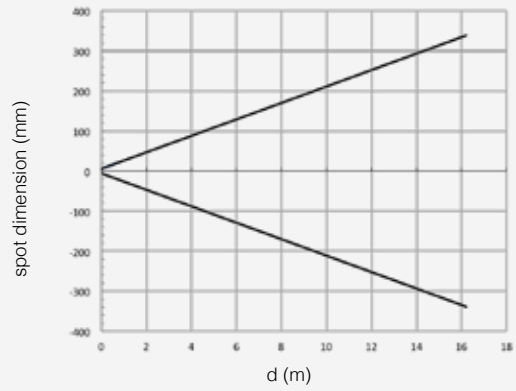

RXC/\*\*-\*\* parallel displacement

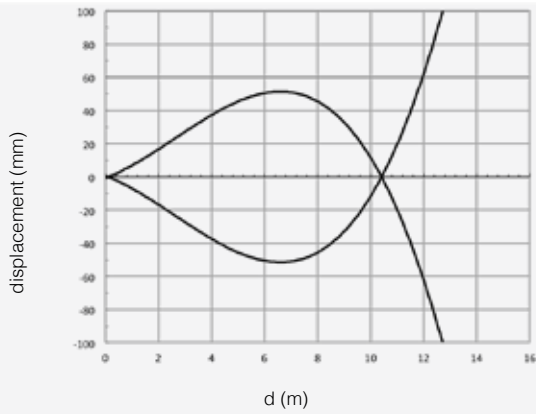

RXC/\*\*-\*\* excess gain

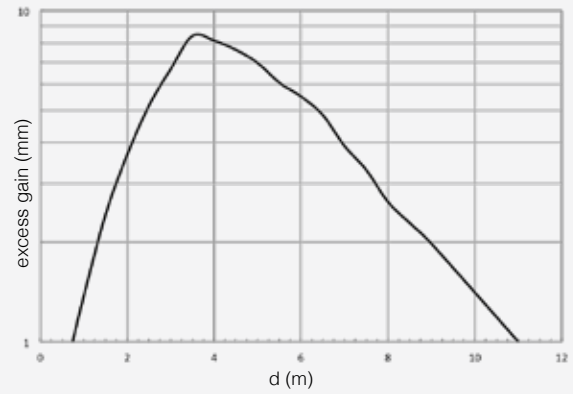

RXC/\*\*-\*\*spot dimension

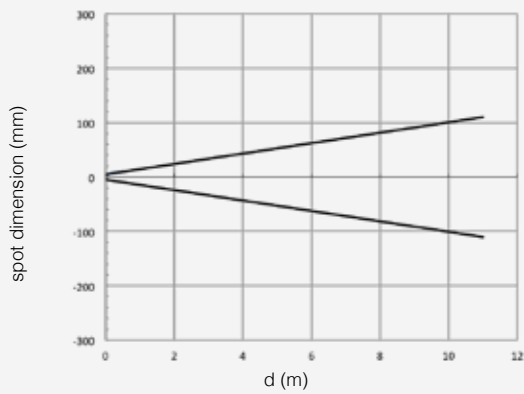

RXC/\*\*-\*\* parallel displacement

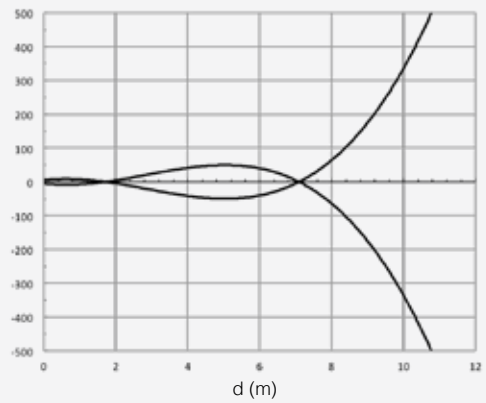

# response diagrams

background suppression models



Maxi with static output DC or with relay output AC/DC

RXS/\*\*-\*\*-\*\* reduction of sensing distance

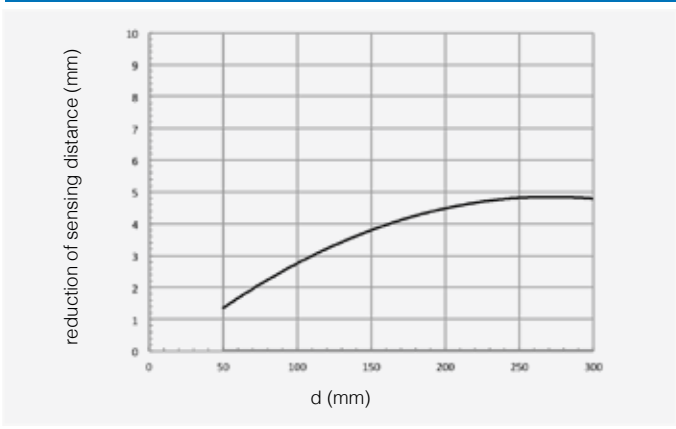

RXS/\*\*-\*\*-\*\* spot dimension

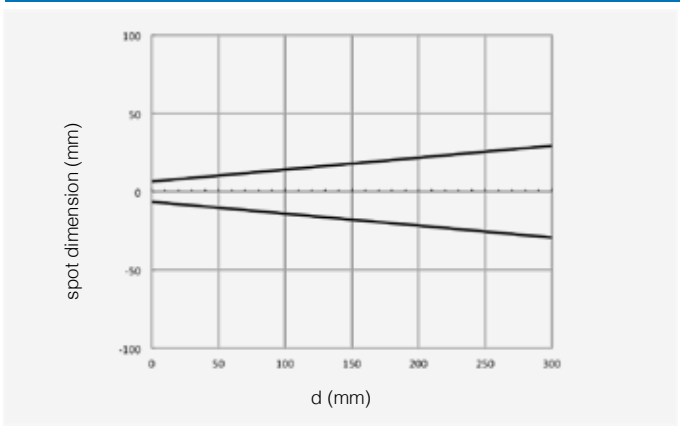

RXL/\*\*-\*\*-\*\* parallel displacement

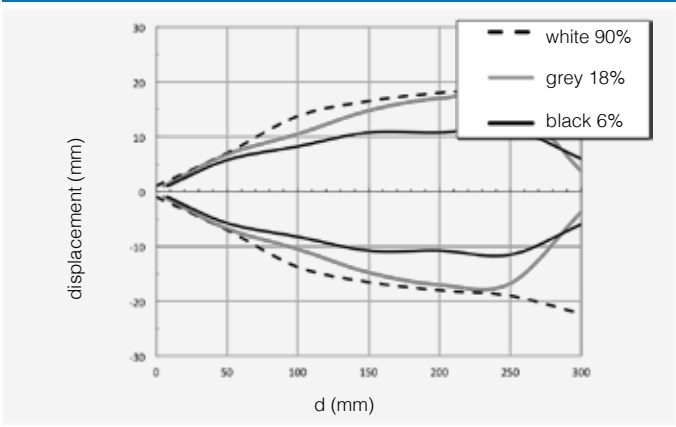

RXL/\*\*-\*\*-\*\* reduction of sensing distance

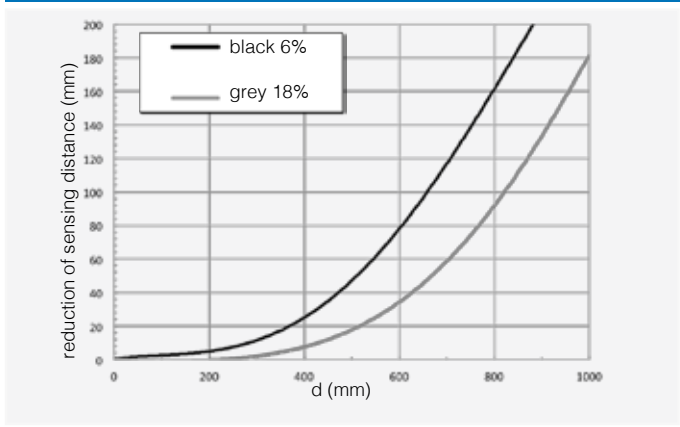

RXL/\*\*-\*\*-\*\* spot dimension

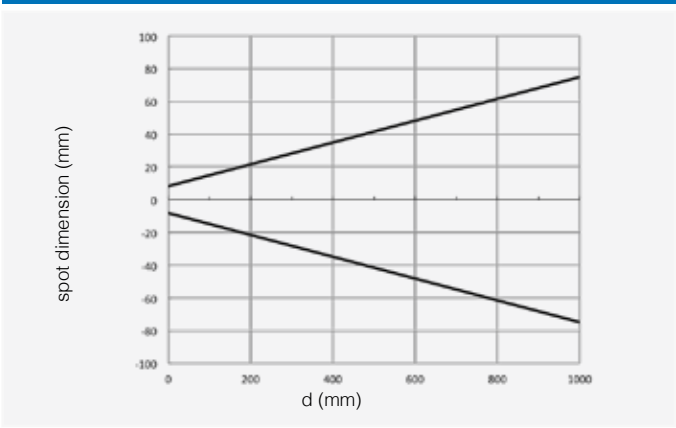

RXL/\*\*-\*\*-\*\* parallel displacement

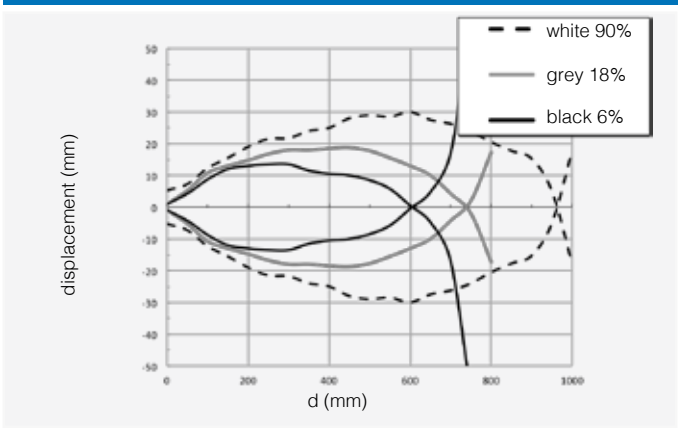



# response diagrams

through-beam models

Maxi with static output DC  
or with relay output AC/DC

RXE/00-0\* - RXR/00-0\* excess gain

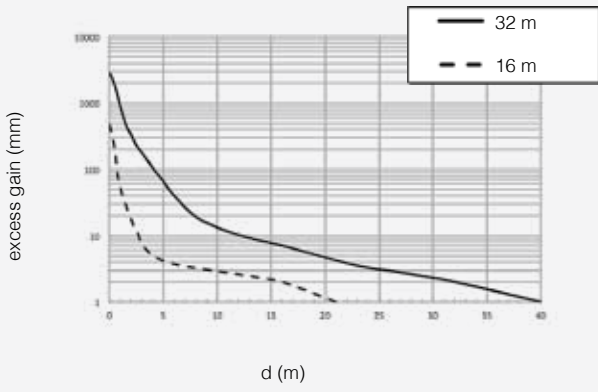

RXE/00-0\* - RXR/00-0\* spot dimension

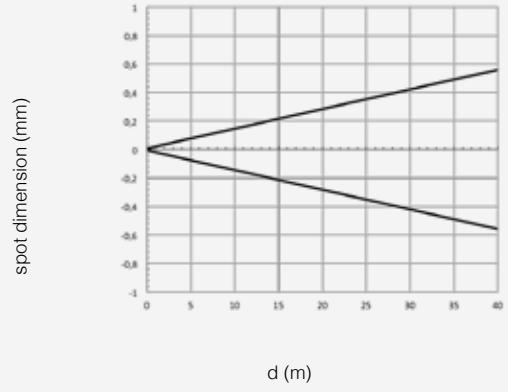

RXE/00-0\* - RXR/00-0\* parallel displacement

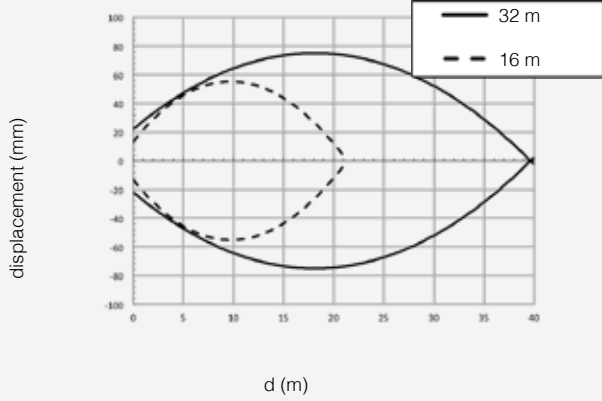





RX\*/\*\*-\*A

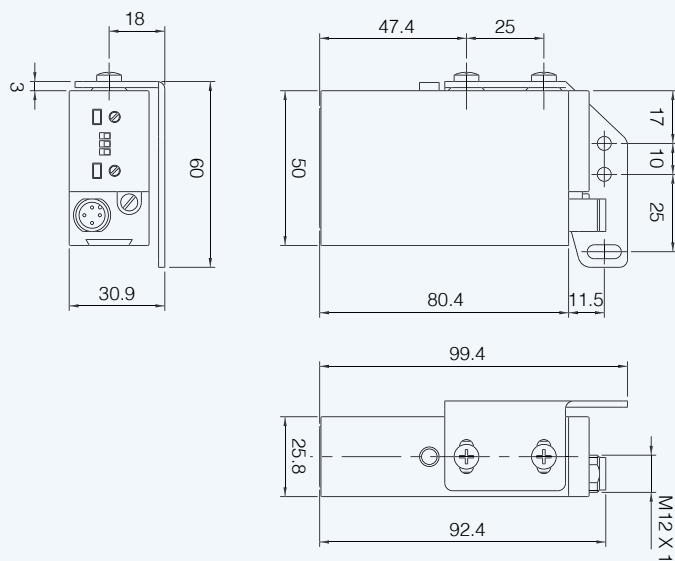

RX\*/\*\*-\*B

